



# Garage Doors RollMatic

Roller garage door RollMatic, horizontal door RollMatic OD

**HÖRMANN**



## CONTENT

6	Good Reasons to Try Hörmann
12	Door styles
16	Colour
20	Roller garage door RollMatic
25	External roller garage door RollMatic
26	Overhead garage door RollMatic OD
30	Side doors
32	Operator accessories
36	Dimensions and fitting data

Some of the doors shown are equipped with optional extras and do not always correspond to our standard models.

The surface finishes and colours shown are subject to the limitations of the printing process and cannot be regarded as binding.

All rights reserved. No part may be reproduced without our prior permission. Subject to changes.

◀ Roller garage door in White aluminium RAL 9006 and Hörmann aluminium entrance door ThermoSafe style 860 in White aluminium RAL 9006



## Universally applicable

Roller garage doors and overhead garage doors open vertically and require minimum space inside the garage. This construction principle means you can make full use of the space inside and in front of the garage. The shape of the garage door opening is not of prime importance when fitting roller garage doors. Whether square, chamfered, with segmental or Norman arch – a Hörmann roller garage door always fits.

With the roller garage door RollMatic the ceiling remains free and can be used for lamps or as an additional storage space. The RollMatic is also available as an external roller garage door for fitting with low headroom and / or sideroom.

The overhead garage door RollMatic OD offers a minimum headroom and is ideally suited for modernisation in tight spaces.





“A good reputation must be earned.”

August Hörmann

In line with the founder's philosophy, the Hörmann brand today is a true promise of quality. The family-owned company has over 80 years of experience in door and operator construction and, with sales of over 20 million doors, is no. 1 in Europe. This makes Hörmann roller garage doors and overhead garage doors a reassuring purchase.



## 1 Brand quality “Made in Germany”

All doors and operator components are developed and manufactured by Hörmann, are **perfectly matched** to each other and **tested and certified** by independent, recognised institutes to ensure your safety. They are manufactured in Germany according to the DIN ISO 9001 quality management system and meet the requirements of European standard 13241-1. Furthermore, our highly qualified employees work intensively on new products, continual further developments and improvements to details. The results are patents and unique products on the market.



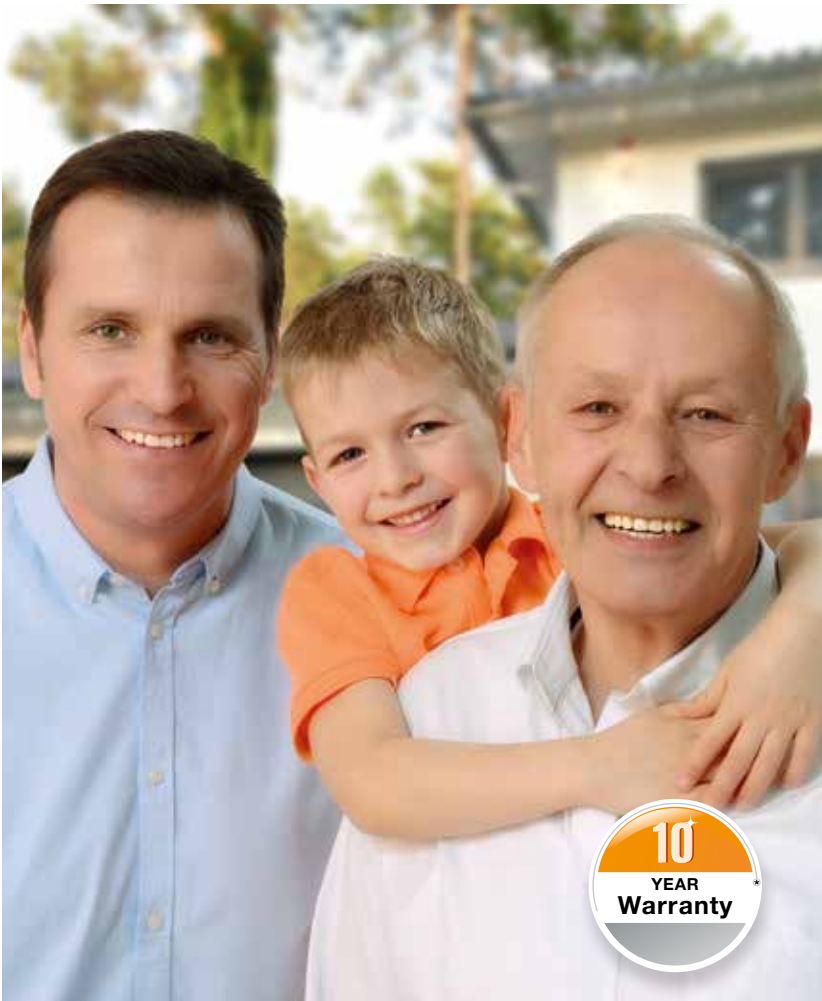

## 2 Garage doors for generations

Endurance tests under real conditions ensure mature series products with Hörmann quality. Thanks to this, excellent technical solutions and uncompromising quality assurance, you receive a **10-year warranty on all Hörmann roller garage doors RollMatic and overhead garage doors RollMatic OD as well as 5 years on all Hörmann operators.\***

\* The complete warranty conditions can be found at: [www.hoermann.com](http://www.hoermann.com)

## 3 An eye on the future

Hörmann is setting a good example. This is why the company obtains **100 % of its required energy from green sources**. At the same time, many tonnes of CO<sub>2</sub> are saved each year thanks to the introduction of an intelligent and certified energy management system. And last but not least, Hörmann also offers products for sustainable construction.



## 4 Reliable counterbalance



Only from Hörmann

Roller garage door with tension spring assembly

A counterbalance system **integrated in the side guides** supports the operator during the opening and closing of the door and **prevents damage to the operator mechanism**. The multiple spring assemblies and the double lifting cables prevent the door leaf from crashing to the floor in every position. In case of emergency, the door can be easily opened by hand. A crank handle is not necessary for this purpose for roller garage doors.

## 5 Reliable automatic safety cut-out

RollMatic doors are subject to minimum wear due to **the standard operators with soft start and soft stop**. The counterbalance system and the **reliable automatic safety cut-out** securely stops the door if it encounters an obstacle. For even more protection and safety, we recommend fitting a non-contact photocell.





## 6 Compact roller garage door

Roller garage doors RollMatic are the best choice if the **ceiling area of your garage** should remain **free** and if your garages are too small for a overhead garage door or sectional door. The door curtain **compactly winds up into the lintel** of the door opening, thus allowing you to use the ceiling for lamps or as an additional storage space. The RollMatic is also available as an **external roller garage door for fitting in front of the opening** with low sideroom.



## 7 Space-saving overhead garage door

For garages with a **particularly low headroom**, overhead garage doors RollMatic OD are especially suitable. The door curtain is guided under the ceiling through narrow side guides. Due to the space-saving, lateral operator fitting, the RollMatic OD has a **required headroom of only 60 mm**.



## 8 BiSecur radio system with certified security

 Only from Hörmann

The bi-directional BiSecur radio system is based on **future-oriented technology** for the convenient and secure operation of garage and entrance gate operators, door operators, lighting and more. The extremely secure BiSecur encryption protocol, developed by Hörmann, with a stable, interference-free range makes sure that no-one can copy your radio signal. It was tested and certified by security experts at Bochum University.



See the short film at:  
[www.hoermann.com/videos](http://www.hoermann.com/videos)

## Perfectly matched and 100 % compatible

**All BiSecur operators, receivers and control elements are 100 % compatible.** Using a hand transmitter or radio code switch, for example, you can conveniently operate your garage door as well as an entrance gate equipped with a Hörmann operator, your door operators or other devices with BiSecur receivers. With our app\* and the Hörmann BiSecur gateway, you can conveniently control your Hörmann garage door or entrance gate operators, Hörmann entrance door\*\* or the internal door operator PortaMatic as well as other devices using your **smartphone or tablet.**

\* For smartphones or tablets with iOS or Android operating systems

\*\* To use this function it is required that your Hörmann entrance door ThermoCarbon / ThermoSafe is equipped with the automatic lock S5 / S7 Smart.



## 9 Convenient querying of the door position

**You no longer have to go out in any wind and weather** to check if your overhead garage door RollMatic OD is closed. At the press of a button, the colour of the LED on the HS 5 BS hand transmitter indicates the position of the door. If required, another push of a button\*\*\* closes the door. It is the most comfortable and secure way to control your door.

\*\*\* An additional photocell is required for operation without visual contact to the door

## 10 Award-winning design

In addition to a black or white design, the **exclusive BiSecur hand transmitters** are characterised by an elegant shape that fits easily in the palm of your hand. Hörmann's BiSecur hand transmitters with an optional high-gloss surface in a piano lacquer look have received the reddot design award for their exclusive design.



See the short film at:  
[www.hoermann.com/videos](http://www.hoermann.com/videos)

Figure above: Hand transmitter HS 5 BS with hand transmitter station (optional).



# The perfect match for your home

To perfectly match your door to the architectural style of your home, we offer the roller garage door RollMatic and the overhead garage door RollMatic OD in various styles. For a natural door style, select one of the two timber designs of the Decograin or Decopaint surface finishes. For an especially elegant door style, we recommend the colour Noir 2100 Sablé Anthracite Metallic. You can also select one of the 11 equally-priced colours – giving you more options for customisation. It goes without saying that we also offer matching side doors.







## DOOR STYLES



► Roller garage door and side door  
in Traffic white RAL 9016







▼ External roller garage door Light grey  
RAL 7035



▲ Overhead garage door RollMatic OD  
in Anthracite grey RAL 7016

◀ Roller garage door in Traffic white RAL 9016  
and Hörmann aluminium entrance door  
ThermoSafe style 413 in Traffic white RAL 9016

## Harmonious overall appearance

The smooth surface of the aluminium profiles looks modern and elegant, unlike the ribbed profiles from other suppliers. Furthermore, a high-quality coating on the inside and outside of the door's surface makes it easy to clean. Only Hörmann offers you the complete door in the selected door colour without a surcharge. The door curtain, side guides, fascia panel, and shaft cover are thus combined in an attractive and harmonious unit. The hollow space of the profile is evenly filled with polyurethane rigid foam for quiet door travel.

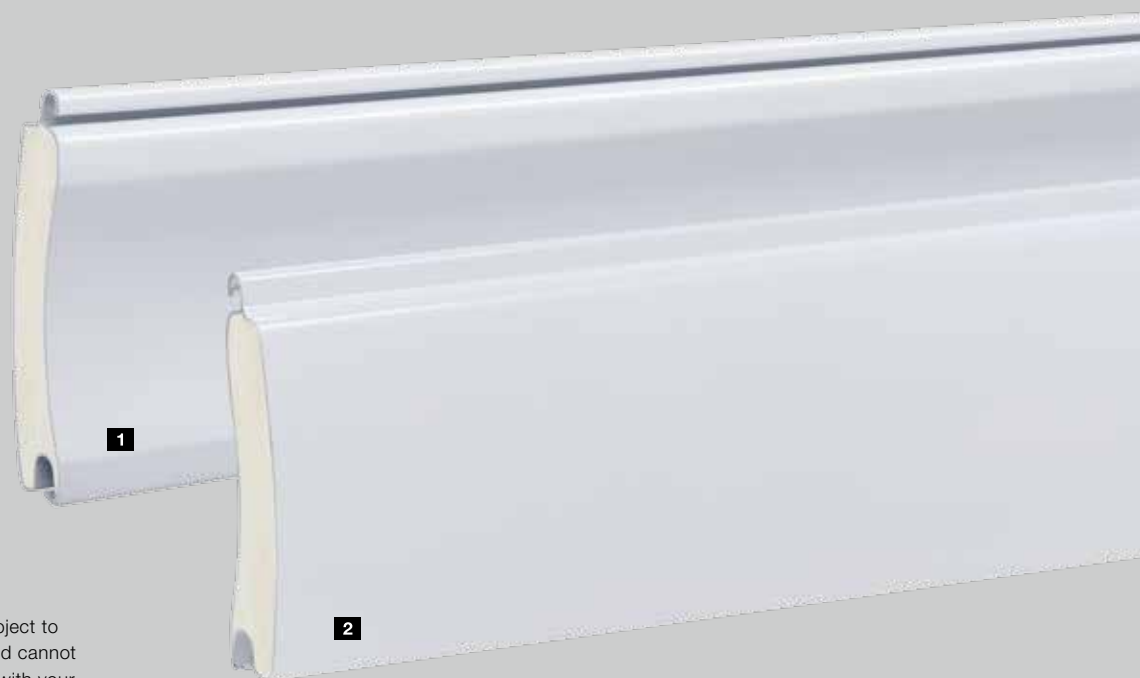

**Please note:**

All colours based on RAL.

The colours and surfaces shown are subject to the limitations of the printing process and cannot be regarded as binding. Please consult with your local Hörmann specialised dealer.

With respect to their technical properties and the paint system used all Hörmann roller garage doors correspond to the current state of the art. Pressure marks and abrasive wear are design-related and cannot be avoided. They do not impair the function and the durability of the roller garage door.

- 1 Profile view (concave side)
- 2 Profile view (convex side)

## 11 equally-priced colours



- 1 RAL 9016 Traffic white
- 2 RAL 9006 White aluminium
- 3 RAL 9005 Jet black
- 4 RAL 9001 Cream
- 5 RAL 8028 Terra brown
- 6 RAL 7035 Light grey
- 7 RAL 7016 Anthracite grey
- 8 RAL 6005 Moss green
- 9 RAL 5011 Steel blue
- 10 RAL 3003 Ruby red
- 11 RAL 1015 Light ivory

## Glazing elements

Get more daylight in your garage. The glazing elements with synthetic panes are arranged across the entire profile width. The number of elements depends on the respective door width. A maximum of ten profiles can be fitted with glazings in each door.

## Ventilation grilles

Ventilation of your garage improves the room climate and prevents mould. Ventilation grilles made of long-lasting plastic are arranged across the entire profile width. Each door can be equipped with a maximum of ten profiles.

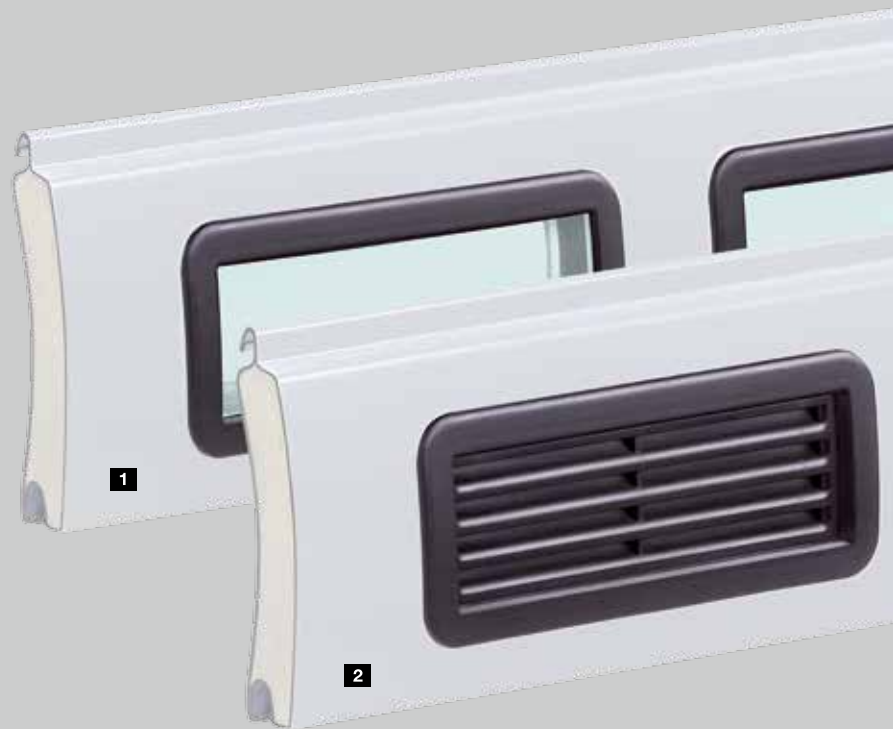

- 1 Profile with synthetic glazing
- 2 Profile with ventilation grille



# Decograin surface finish

The two Decograin decors in the colours Golden Oak and Rosewood have a convincingly real timber look. A special abrasion-resistant surface protection preserves the UV-resistant plastic film coating on the profiles over a long time.

## Decograin decors

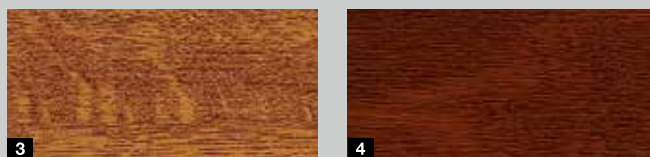

## Roller garage door RollMatic

To create a uniform appearance when fitting in the opening, we supply the side guides as well as the additional fascia panel in a matching Decograin decor. For fitting behind the opening, the side guides are powder-coated in the base colour of the decor and the additional fascia panel is supplied in the matching Decograin decor. The Decograin surface finish is not available for external roller garage doors.

## Overhead garage door RollMatic OD

The side guides and the fascia panel are powder-coated in the base colour of the decor.

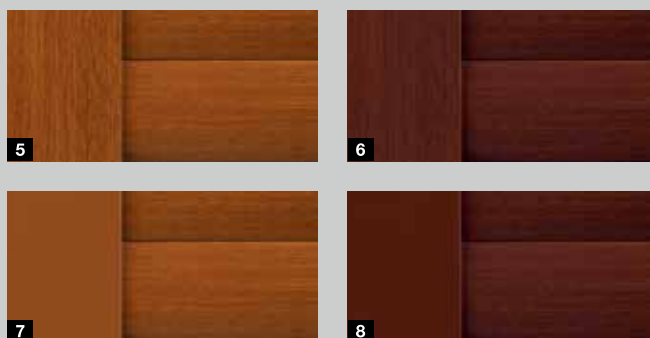

**Please note:**

The colours and surfaces shown are subject to the limitations of the printing process and cannot be regarded as binding. Please consult with your local Hörmann specialised dealer.

- 1 Profile view (concave side) in brown
- 2 Profile view (convex side) in Decograin Golden Oak
- 3 Decograin Golden Oak
- 4 Decograin Rosewood
- 5 Side guide and profile in Decograin Golden Oak
- 6 Side guide and profile in Decograin Rosewood
- 7 Side guide in the base colour in Decograin Golden Oak
- 8 Side guide in the base colour in Decograin Rosewood

# Decopaint surface finish

The Decopaint decors Golden Oak and Rosewood are an inexpensive alternative to Decograin surface finishes. The interior and exterior of the profiles are painted to look like timber. An elegant Anthracite Metallic paint is used for the colour Noir 2100 Sablé.



## Decopaint decors

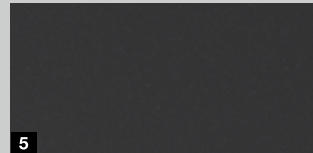

## Roller garage door RollMatic / overhead garage door RollMatic OD

The side guides, fascia panel and curtain cover are powder-coated in the base colour of the decor to create a harmonious appearance.



- 1 Profile view (concave side) in Decopaint Golden Oak
- 2 Profile view (convex side) in Decopaint Golden Oak
- 3 Decopaint Golden Oak
- 4 Decopaint Rosewood
- 5 Noir 2100 Sablé Anthracite Metallic
- 6 Side guide in the base colour of the decor
- 7 Side guide in the base colour of the decor
- 8 Side guide and profile in Noir 2100 Sablé Anthracite Metallic

## Details perfectly matched to each other



The roller garage door RollMatic features a wide variety of innovative details with a single objective: providing you with security and comfort. From the particularly simple fitting through to the sophisticated safety patents, this concept runs through all aspects of the product.







**2** Only from Hörmann Tension spring assembly

### 1 A well-protected shaft

The standard shaft cover practically prevents reaching into the door barrel. In addition, it protects the curtain from damage and dirt when the door is open. For coloured doors or doors with a Decograin surface finish, the cover matches the door curtain. For Decopaint doors, the cover is supplied in the base colour of the door.

### 2 Tension spring assembly with multi-spring system

Hörmann RollMatic roller garage doors with double tension springs and double lifting cables protect the door leaf from crashing in every door position. The patented multi-spring system and the transparent protective cover prevent broken springs from flying out and thus protect from personal injury.



**3** Only from Hörmann Wear-resistant bearing rings

### 3 Wear-resistant bearing rings

The use of wear-resistant materials reduces marks of the bearing rings on the top door curtain profiles.

### 4 Standard wind locks

The Hörmann RollMatic roller garage doors can even withstand large wind loads (up to class 4). The wind locks fitted as standard in the profile ends keep the door securely within its guides. An additional advantage is increased break-in resistance.



### 5 Easy fitting

RollMatic roller garage doors can be fitted quickly and easily. The side guides, fascia panel and operator are bolted to the garage walls and lintel. The curtain is then pulled effortlessly onto the shaft by the operator and fixed via belts.



For more information, consult the technical manual under [www.hoermann.de](http://www.hoermann.de)



Standard operator, fitted outside of the cover for trouble-free maintenance

- As standard with 4-button hand transmitter HSE 4 BS
- Low power consumption
- Adjustable automatic timer\*\*
- Standard emergency release via a pull cord

## Control

- Separate housing with control buttons
- Integrated illumination



Standard hand transmitters HSE 4 BS, textured surface black with plastic caps

Garage door operators	Standard operator
Cycles per day / hour	25 / 10
Pull and push force	650 N
Peak force	800 N
Max. opening speed	11 cm/s

\* The complete warranty conditions can be found at: [www.hoermann.com](http://www.hoermann.com)

\*\* Photocell is required



## Optional extras

### Optional emergency release from the outside **1**

For garages without a second access door, we recommend the emergency release function allowing you to open your garage door from the outside in case of emergency (e.g. power failure).



### Optional emergency battery **2**

With this emergency power supply, you can bypass network power failures for up to 18 hours and max. 5 door cycles. The emergency battery recharges during normal operation.



### Optional acoustic alarm **3**

The shrill alarm sound with a volume of 110 db (A) effectively deters burglars.

### Manually operated door with manual locking

Thanks to the supporting tension spring compensation, Hörmann roller garage doors can be easily opened and closed manually from the outside and inside. From the outside using the handle **4** and from the inside with a pull chain **5**.

The manually operated roller garage door is mechanically locked using interior and exterior handles and a lock. Solid metal bolts extend on the right and left into the side guide.



**Only from Hörmann** Tension spring assembly



## Optional extras

### Chamfered bottom profile

The solution for sloping ground: A chamfered aluminium bottom weather seal compensates for differences in height over the entire door width (max. 300 mm). The profile can be fitted without any difficulty. It is simply screwed onto the inserted curtain. The bottom profile is delivered powder-coated in Jet black (similar to RAL 9005) as standard. On request, the bottom profile **1** is also available in a colour matching the door colour.

### Additional fascia panel

The additional fascia panel **2** stabilises the fascia panel during fitting in the opening or behind the opening, if the fascia panel can be seen in the opening. It harmoniously covers the lintel without any unattractive fitting holes. The additional fascia panel is available in the colour of the door or with a Decograin surface.

### Fitting compensation set

With uneven walls, the optional fitting compensation set **3** for flush door fitting can be applied. This is particularly advantageous for modernisations or timber structures.

For more information, consult the technical manual under [www.hoermann.de](http://www.hoermann.de)





## External roller garage door

The solution for areas with a lack of interior sideroom

The RollMatic is also available as an external roller garage door for fitting in front of the opening if your garage has little lintel space and / or sideroom. The external roller garage door is supplied as a complete package with a matching operator. The side guides and the curtain cover come in the same colour as the door to create a uniform and harmonious appearance.

### 1 Variable operator positions

Depending on the fitting situation, operators for external roller garage doors can either be installed on the left or right. The shaft cover is 100 mm wider in this area and encloses the operator, protecting it from adverse weather effects or from unauthorised interference.



### 2 Tension spring cladding with vision sections

The vision sections in the spring cladding allow you to conveniently check whether the cable guide or springs are still functional. This gives you security even after many years of use.



### 3 Secured release

The operator can be easily released from the inside using a hand pulley. This allows you to open your door manually from the inside during a power failure, for example. Optionally, the secured release is also available for fitting to exterior walls in a lockable housing. For further information, please see page 23.

## The space-saving garage door – ideal for modernisation



The narrow design of the overhead garage door RollMatic OD allows fitting in the garage even in very tight spaces.







### 1 Smooth door travel

Twin rollers evenly and smoothly guide the door curtain under the ceiling. The narrow aluminium side guides are connected by stable corner diversions with small radii. Due to this compact design the overhead garage door RollMatic OD only requires a lintel of 60 mm.



### 2 Well-sealed

An elastic lip seal in the lintel area and brush seals in the side guides protect against driving rain (class 2). The flexible EPDM bottom profile compensates for unevenness in the floor and seals the bottom edge of the door.

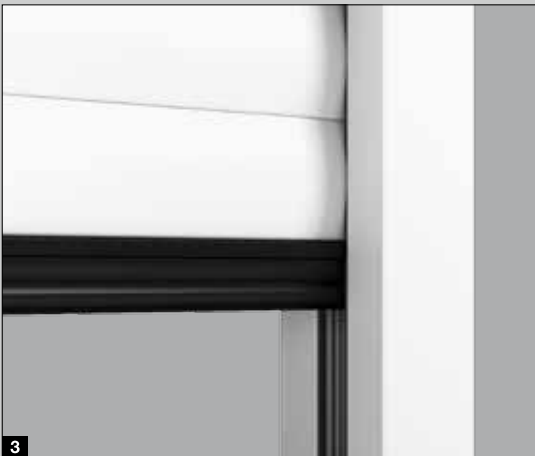

### 3 Integrated counterbalance

The multiple spring assemblies optimally balance the weight of the door curtain in every position. This preserves the operator mechanism and, together with the automatic safety cut-out of the operator, guarantees safe door operation. In addition, the integral catch safety device protects the door against crashing to the floor in case of a possible cable tear.

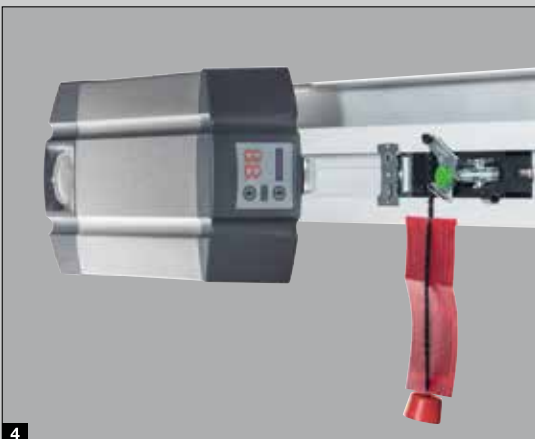

### 4 Space-saving operator fitting

The operator booms can either be installed on the right or the left horizontal side guide. This compact design does not require additional headroom. (The illustration shows the optional SupraMatic operator)

### Variable fitting

The vertical side guides and the fascia panel are supplied in the colour of the door as standard. Thus the door can also be fitted partially or completely in the opening.



# ProMatic – the standard operator

- As standard with 4-button hand transmitter HSE 4 BS
- Query of the door position with optional hand transmitter HS 5 BS
- Adjustable ventilation slot
- Automatic door locking



Standard hand transmitters HSE 4 BS, textured surface black with plastic caps

Garage door operators	ProMatic
Cycles per day / hour	12 / 5
Pull and push force	600 N
Peak force	750 N
Max. opening speed	14 cm/s

# SupraMatic – the supra-fast operator with many additional functions



- As standard with one 5-button hand transmitter HS 5 BS
- Querying of the door position
- Low power consumption
- Easy to program
- 2x 7-segment display
- Adjustable ventilation slot
- Automatic door locking
- Operator cover made of brushed aluminium



Standard hand transmitter  
HS 5 BS, textured  
surface black

Garage door operators	SupraMatic E
Cycles per day / hour	25 / 10
Pull and push force	650 N
Peak force	800 N
Max. opening speed	22 cm/s

\* The complete warranty conditions can be found at: [www.hoermann.com](http://www.hoermann.com)



## Optional extras

### Emergency battery HNA for garage door operators ProMatic and SupraMatic **1**

Emergency power supply to bypass power failures up to 18 hours and max. 5 door cycles, recharges during normal operation, for all current Hörmann garage door operators.

### Emergency release **2**

We recommend an additional emergency release lock for garages without a second entrance. An inconspicuous round cylinder (cannot be integrated in the home locking system) releases your garage door and you can easily open it in the case of an emergency.

### Retrofit fascias **3**

Using the optional retrofit fascias, the door is fitted in the reveal and at the same time covers unattractive gaps in the lintel and opening areas. Additional brickwork and plastering work are no longer required

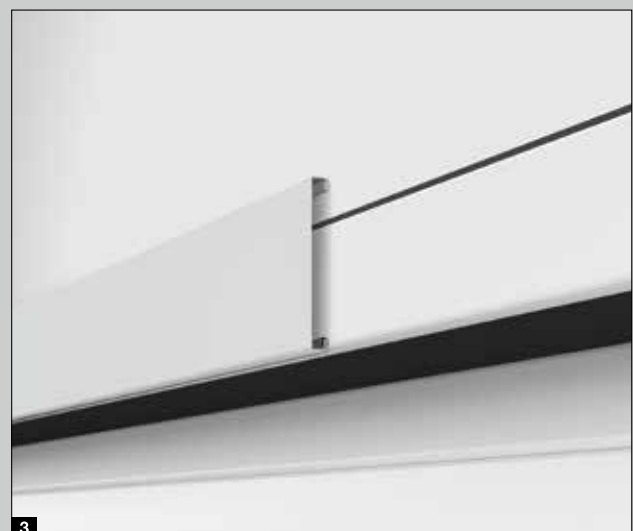
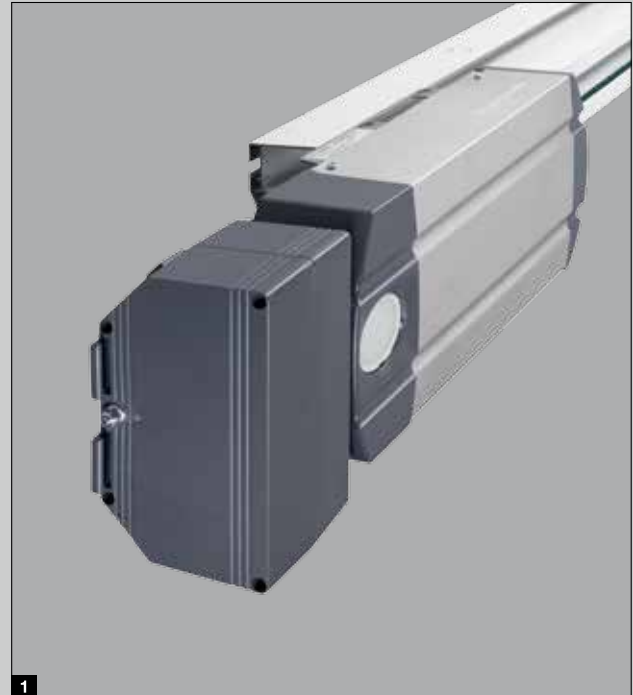

## A matching side door for every RollMatic door

At Hörmann, side doors are given just as much consideration, as the overall appearance is only perfect if the side door matches the roller garage door. The side door NT 60 is thus available in all surface finishes and colours. The high-quality 60 mm aluminium frame construction is the ideal frame for the door infill and is fastened with glazing beads as standard.



External view



Interior view



Lever handle set as standard

## For even more comfort

Hörmann operator accessories are characterised by innovative technology, exclusive design and 100 % compatibility – the ideal combination for everyone who values perfection.

You want maximum comfort?

We have the right control element for all your wishes and needs: elegant hand transmitters, stationary radio buttons or beautiful radio internal push buttons – choose your favourite.











**Hand transmitter HS 5 BS**

4 button functions,  
plus query button,

1 High-gloss surface black  
or white

2 Textured surface black



**Hand transmitter HS 4 BS**

4 button functions,

3 Textured surface black

**Hand transmitter HS 1 BS**

1 button function,

4 Textured surface black

**Hand transmitter HSE 1 BS**

1 button function,  
incl. eyelet for key ring

5 Textured surface black



**Hand transmitter HSE 4 BS**

4 button functions,  
including. eyelet for key ring

6 Textured surface black  
with chrome or plastic caps

**Hand transmitter HSE 2 BS**

2 button functions,  
including eyelet for key ring

7 High-gloss surface black  
or white

8 High-gloss surface green,  
purple, yellow, red, orange

9 Decors in silver, carbon,  
dark rootwood

(Shown from left to right)





**10 Hand transmitter  
HSD 2-A BS**

Aluminium look,  
2 button functions,  
can also be used as a key ring

**11 Hand transmitter  
HSD 2-C BS**

High-gloss chrome,  
2 button functions,  
can also be used as a key ring



**12 Hand transmitter  
HSP 4 BS**

4 button functions,  
with button lock-out  
incl. key ring



**13 Hand transmitter  
HSZ 1 BS**

1 button function,  
for insertion in vehicle  
cigarette lighter

**14 Hand transmitter  
HSZ 2 BS**

2 button functions,  
for insertion in vehicle  
cigarette lighter



**15 Radio internal push  
button FIT 2-1 BS**

For 2 functions  
or 2 operators



**16 Radio code switch  
FCT 3 BS**

For 3 functions,  
with illuminated buttons



**17 Radio code switch  
FCT 10 BS**

For 10 functions,  
with illuminated buttons  
and protective cover



**18 Radio finger-scan  
FFL 12 BS**

For 2 functions  
and up to 12 fingerprints



**Key switch**

**19 STUP 50**

**20 STAP 50**

In a recessed version  
and surface-mounted version,  
incl. 3 keys

# ROLLER GARAGE DOOR ROLLMATIC: DIMENSIONS AND FITTING DATA

## Internal roller garage door

Fitting behind the opening, view of fitting side

## Internal roller garage door

Fitting in the opening, interior view

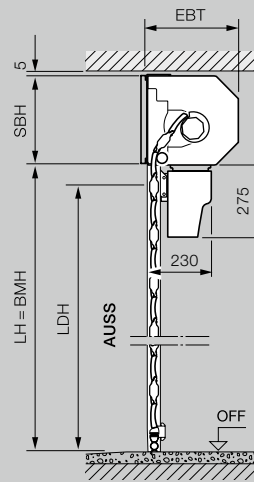
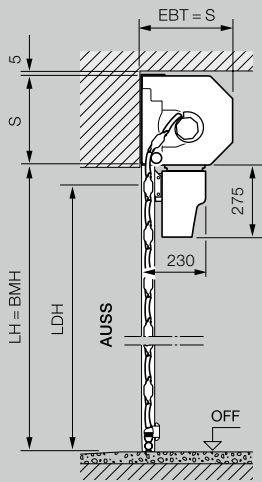
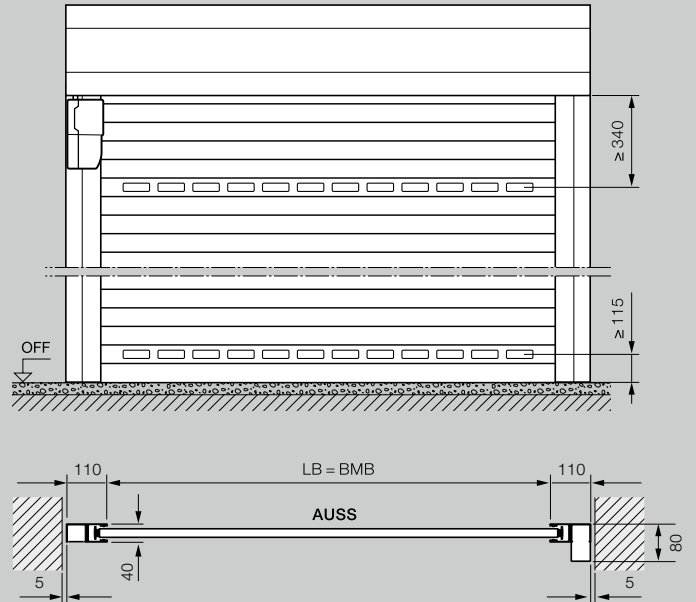
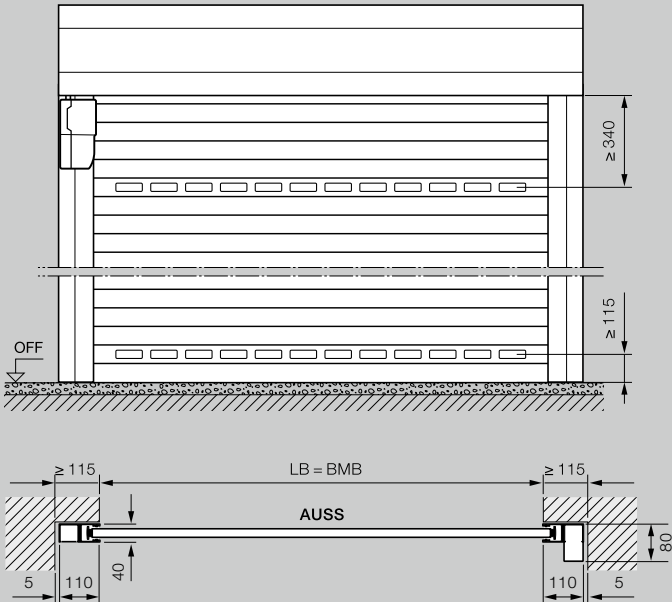

Size range for internal and external roller garage door

Clear height (LH)	3100																			
	3000																			
	2875																			
	2750																			
	2675																			
	2625																			
	2500																			
	2375																			
	2250																			
	2125																			
	2000																			
	1800																			
	1600																			
		1000	1250	1500	1750	1900	2000	2250	2500	2750	3000	3250	3500	3750	4000	4250	4500	4750	5000	
	Clear width (LB)																			

## External roller garage door

Fitting in front of the opening, view of fitting side

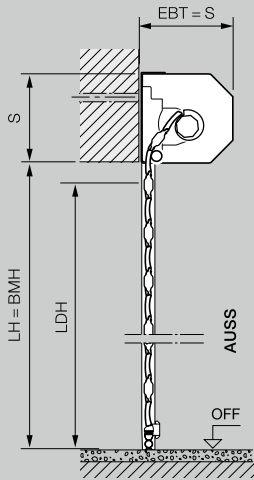
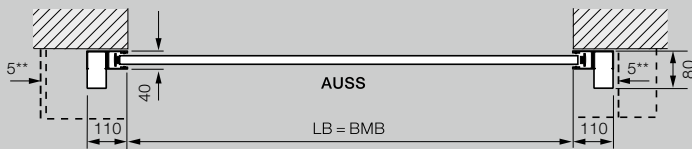
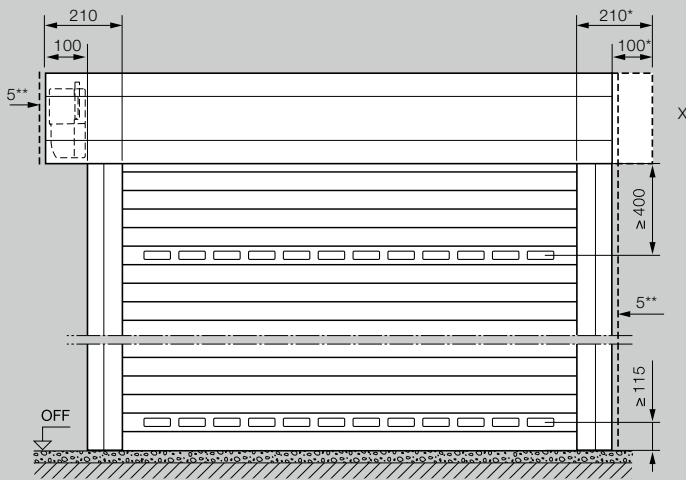

## Explanations

BMB	Ordering size width
BMH	Ordering size height
LB	Clear width
LH	Clear height
LDB	Clear passage width
LDH	Clear passage height
RAMB	Overall frame dimension width
RAMH	Overall frame dimension height
EBT	Fitting depth
S	Required headroom
SBH	Additional fascia panel height
OFF	Finished floor level
AUSS	Exterior

### Fitting depth EBT

Up to 2300 mm door height	290 mm
From 2301 mm door height	335 mm

### Required headroom S / additional fascia panel SBH

Up to 2300 mm door height	290 mm
From 2301 mm door height	335 mm

### Clear passage LD

Height (with operator)	LH – 60 mm
Height (manually operated)	LH – 125 mm
Width	LB

### Side space requirement

External roller garage door operator side	115 mm
	215 mm

### Wind load classes

Up to door widths of 3000 mm	Class 5
Up to door widths of 3750 mm	Class 4
Up to door widths of 4500 mm	Class 3
From door widths of 4500 mm	Class 2

### Water tightness under heavy rain

Class 2

### X External roller garage door cladding

A symmetrical arrangement is also possible, in addition to a variable operator position (as standard on the left, optionally on the right) with projection of the shaft cover on the operator side.

\* For a visually balanced look the barrel casing can be ordered symmetrically!

\*\* At least 5 mm distance from fascia panel / side guide



# OVERHEAD GARAGE DOOR ROLLMATIC OD: DIMENSIONS AND FITTING DATA

## Overhead garage door

Fitting behind the opening, view of fitting side

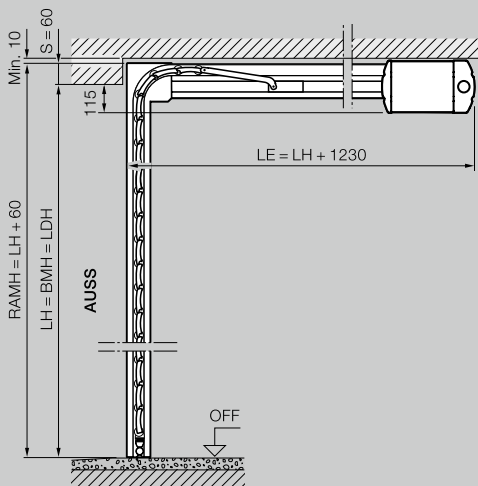
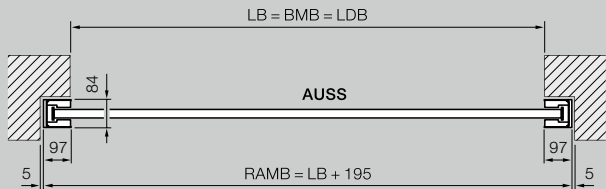
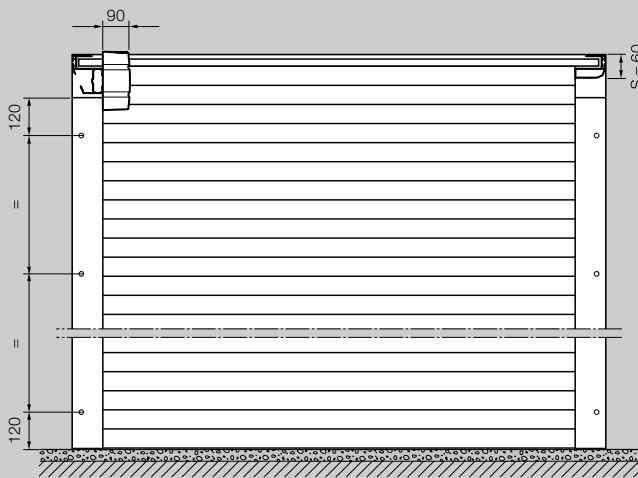

## Overhead garage door

Fitting in the opening, interior view

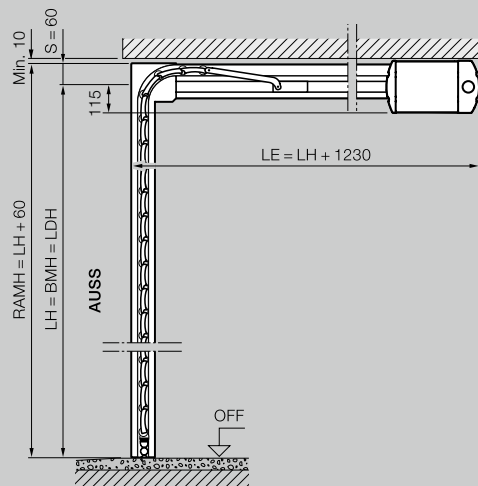
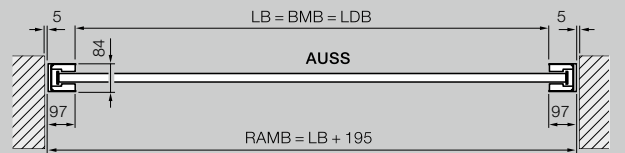
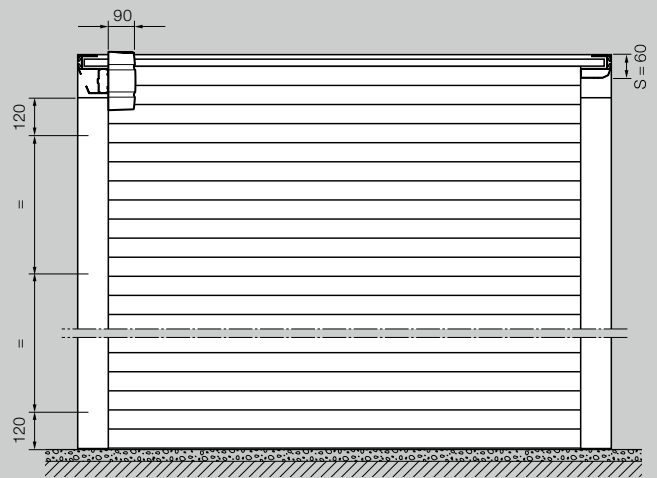

### Size range for overhead garage door RollMatic OD\*

Clear height (LH)	3000											
	2875											
	2750											
	2625											
	2500											
	2375											
	2250											
	2125											
	2000											
	1875											
	1700											
	1000	1250	1500	1750	2000	2250	2500	2750	3000	3250	3500	
	Clear width (LB)											

# Overhead garage door

Flush-fitting in the opening with panel 95

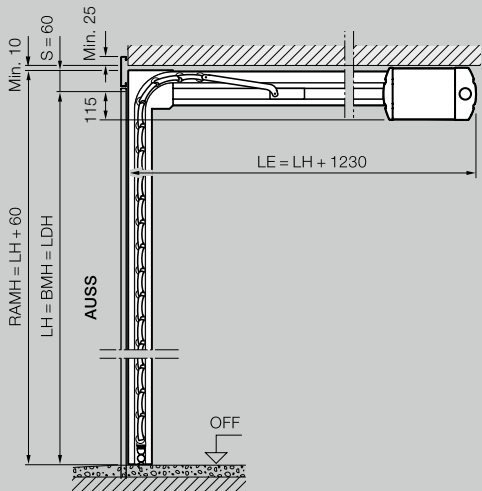
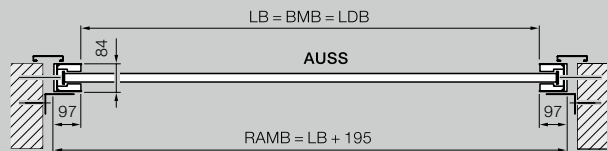
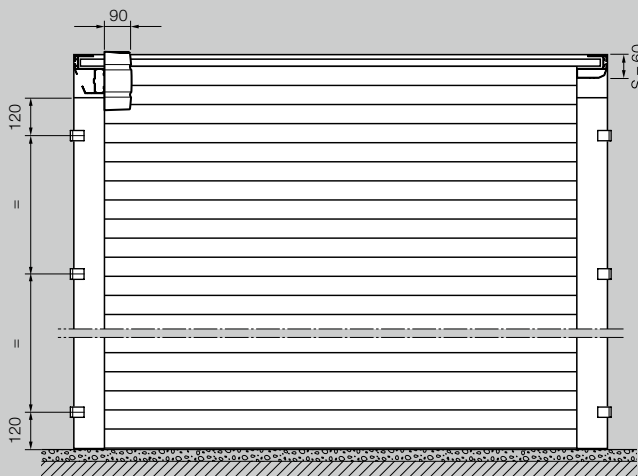

# Explanations

- BMB Ordering size width
- BMH Ordering size height
- LB Clear width
- LH Clear height
- LDB Clear passage width
- LDH Clear passage height
- LMB Structural opening width
- RAMB Overall frame dimension width
- RAMH Overall frame dimension height
- LE Distance back with operator
- S Required headroom
- OFF Finished floor level
- AUSS Exterior

**Side space requirement** 102 mm

**Wind load class**

- Up to door widths of 3000 mm Class 3
- Up to door widths of 3500 mm Class 2

**Water tightness under heavy rain**

Class 2

# SIDE DOOR: DIMENSIONS AND FITTING DATA

Side door with block frame

Fitting behind the opening,  
opening inwards

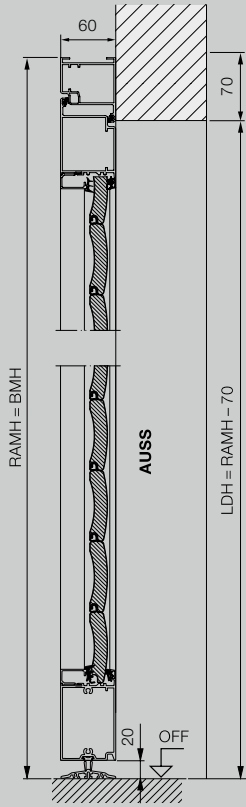

Side door with block frame

Fitting in the opening,  
opening inwards

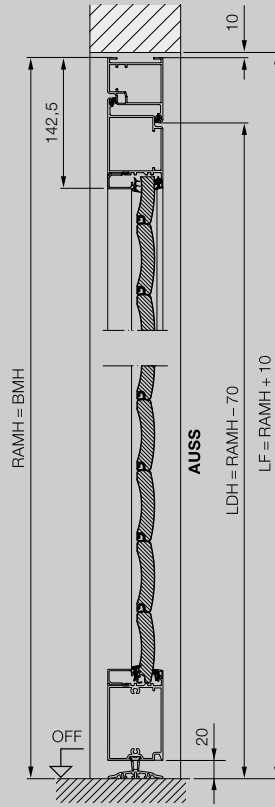

Side door with block frame

Fitting in the opening,  
opening outwards

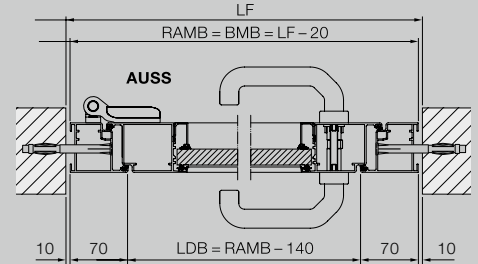
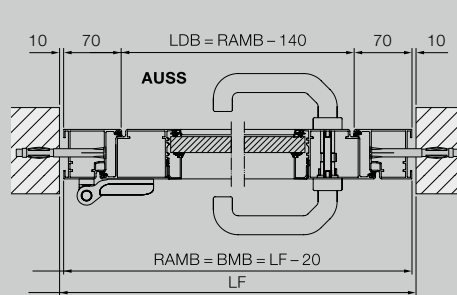
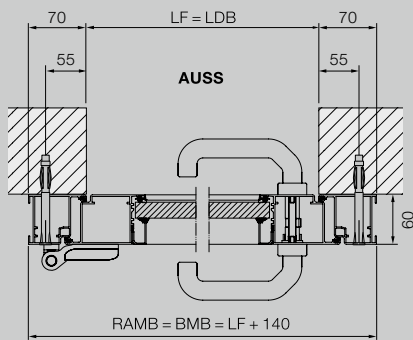
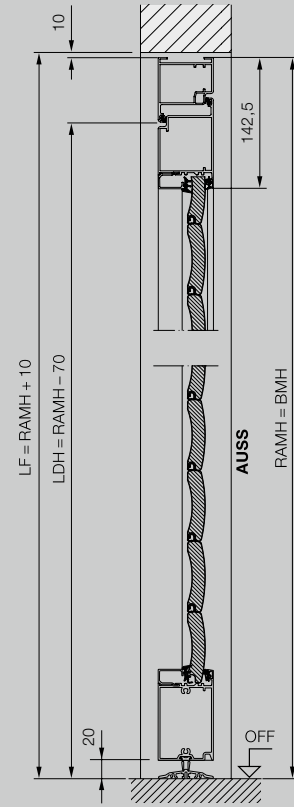

### Side door with corner frame

Internal fitting,  
opening inwards

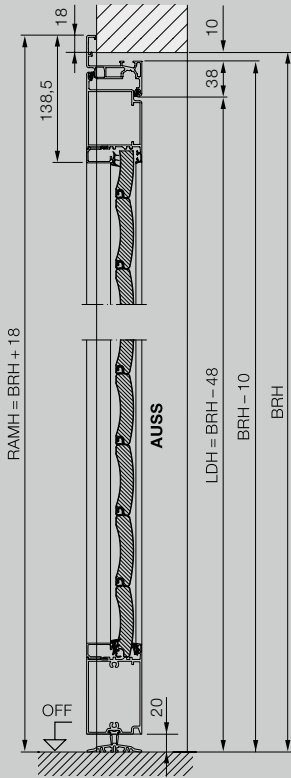

### Side door with corner frame

External fitting,  
opening outwards

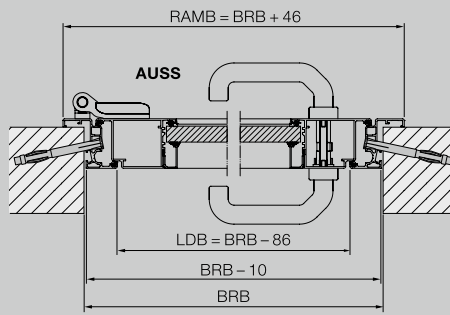
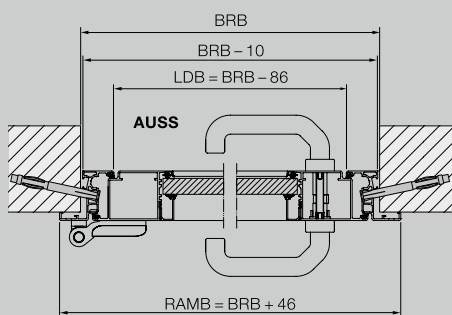
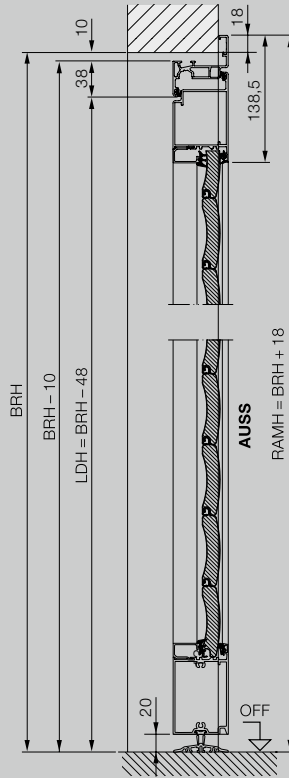

### Explanations

BRB	Nominal size width
BRH	Nominal size height
BMB	Ordering size width
BMH	Ordering size height
LDB	Clear passage width
LDH	Clear passage height
LF	Structural opening
RAMB	Overall frame dimension width
RAMH	Overall frame dimension height
OFF	Finished floor level
AUSS	Exterior

#### Material

Door leaf frame and frame made of galvanized material, polyester powder-coated primer on both sides, with roller garage door section infill. Position of sections does not match the roller garage door RollMatic. Glazing and ventilation grilles arranged as in the roller garage door RollMatic.





HORMANN

# Experience Hörmann quality in new construction and modernisation

Hörmann provides an excellent basis for comprehensive planning. Carefully matched solutions offer you the very best in perfectly designed products for every area.

- **Garage doors**

Optimally match your personal architectural style: up-and-over or sectional doors made of steel or timber.

- **Gate and Door Operators**

Enjoy extra convenience and break-in-resistant security with Hörmann operators for garage doors and entrance gates. You can profit from the convenience of Hörmann door operators in your residential space as well.

- **Entrance doors**

Our comprehensive entrance door ranges include models that fit almost every need and requirement.

- **Steel doors**

Sturdy doors for your entire home, from basement to roof.

- **Frames**

Choose from our comprehensive range of products for new construction, expansion and modernisation.



Garage doors and entrance gate operators



Thermo65 / Thermo46 entrance doors



Steel doors

# Hörmann: Quality without Compromise



Hörmann KG Amshausen, Germany



Hörmann KG Antriebstechnik, Germany



Hörmann KG Brandis, Germany



Hörmann KG Brockhagen, Germany



Hörmann KG Dissen, Germany



Hörmann KG Eckelhausen, Germany



Hörmann KG Freisen, Germany



Hörmann KG Ichttershausen, Germany



Hörmann KG Werne, Germany



Hörmann Alkmaar B.V., Netherlands



Hörmann Legnica Sp. z o.o., Poland



Hörmann Beijing, China



Hörmann Tianjin, China



Hörmann LLC, Montgomery IL, USA



Hörmann Flexon LLC, Burgettstown PA, USA



Shakti Hörmann Pvt. Ltd., India

Hörmann is the only manufacturer worldwide that offers you a complete range of all major building products from one source. We manufacture in highly-specialised factories using the latest production technologies. The close-meshed network of sales and service companies throughout Europe, and activities in the USA and Asia, make Hörmann your strong partner for first-class building products, offering "Quality without Compromise".

**GARAGE DOORS**  
**OPERATORS**  
**INDUSTRIAL DOORS**  
**LOADING EQUIPMENT**  
**HINGED DOORS**  
**DOOR FRAMES**